

SR2121 - KR2121

PORTAPACCO SPECIFICO - SPECIFIC HOLDER - PORTE-PAQUET SPÉCIFIQUE - SPEZIFISCHER TRÄGER - PORTA-EQUIPAJE ESPECÍFICO - TRANSPORTADOR ESPECÍFICO

YAMAHA MAJESTY S 125 (2014)

N°	Descrizione	Caratteristiche	Codice	Quantità
1	Supporto - Support - Support Halierung - Soporte - Apoio	-	2121SRDXS 2121SRSXS	2 (dx-sx)
2	Vite - Screw Vis - Schraube Tornillo - Parafuso	TECF 8x30	830TECF	2
3	Vite - Screw Vis - Schraube Tornillo - Parafuso	TECF 8x40	840TECF	2
4	Distanziale - Spacer Entretoise - Distanzstueck Distanciador - Espaçador	Ø 20x6,2 foro 8,5	C20L6,2F8,5	4
5	Particolari Inclusi Nel Kit Viteria Della Piastra Components Included In The Fitting Kit Of The Plate Pièces Inclues Dans Le Kit De Vis De La Platine Die Einzelnen Teile Sind Bei Montagekit Der Platte Enthalten Despie- ces Incluidos En El Kit De Anclajes De La Parrilla Explodiu incluído no Kit as âncoras da grelha	-	-	-
6	Componenti Originali - Original Parts Parties Originales - Original Bauteile Componentes Originales - Componentes Originais	-	-	-

SR2121 - KR2121

PORTAPACCO SPECIFICO - SPECIFIC HOLDER - PORTE-PAQUET SPÉCIFIQUE - SPEZIFISCHER TRÄGER - PORTA-EQUIPAJE ESPECÍFICO - TRANSPORTADOR ESPECÍFICO

YAMAHA MAJESTY S 125 (2014)

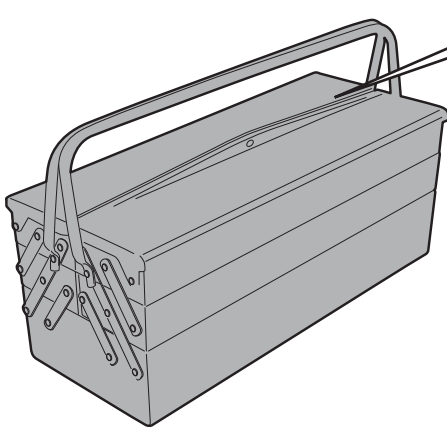
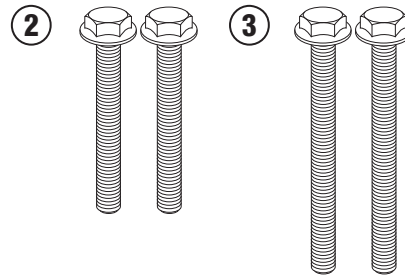
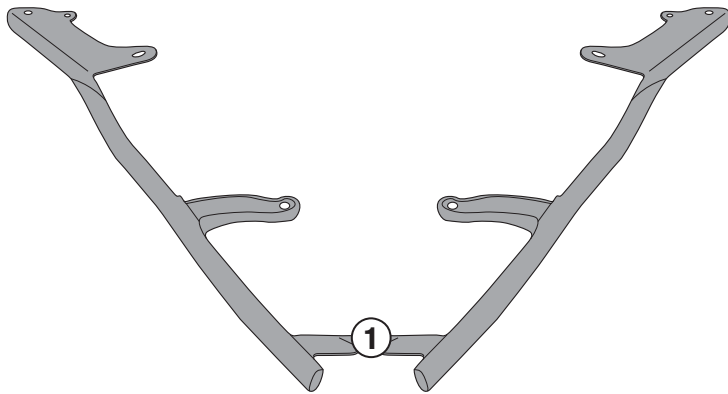

SR2121 - KR2121

PORTAPACCO SPECIFICO - SPECIFIC HOLDER - PORTE-PAQUET SPÉCIFIQUE - SPEZIFISCHER TRÄGER - PORTA-EQUIPAJE ESPECÍFICO - TRANSPORTADOR ESPECÍFICO

YAMAHA MAJESTY S 125 (2014)

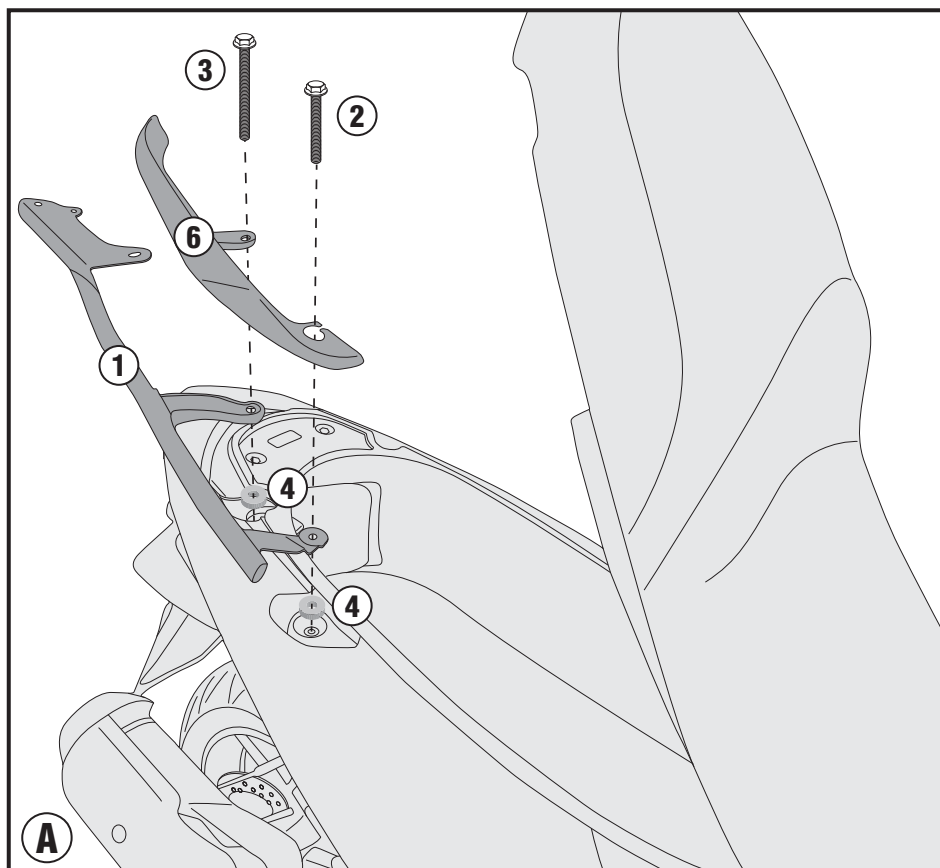
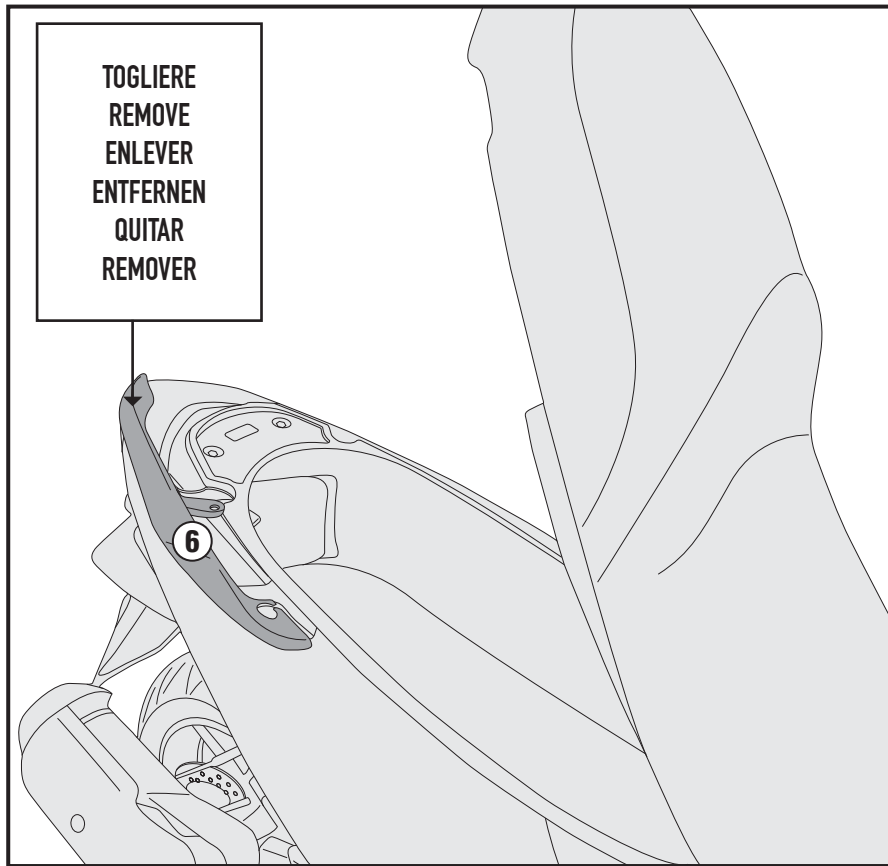

SR2121 - KR2121

PORTAPACCO SPECIFICO - SPECIFIC HOLDER - PORTE-PAQUET SPÉCIFIQUE - SPEZIFISCHER TRÄGER - PORTA-EQUIPAJE ESPECÍFICO - TRANSPORTADOR ESPECÍFICO

YAMAHA MAJESTY S 125 (2014)

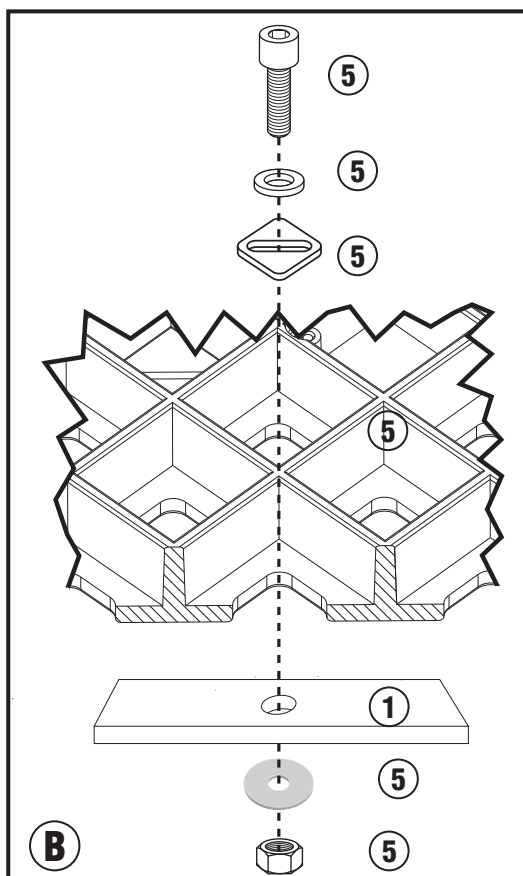
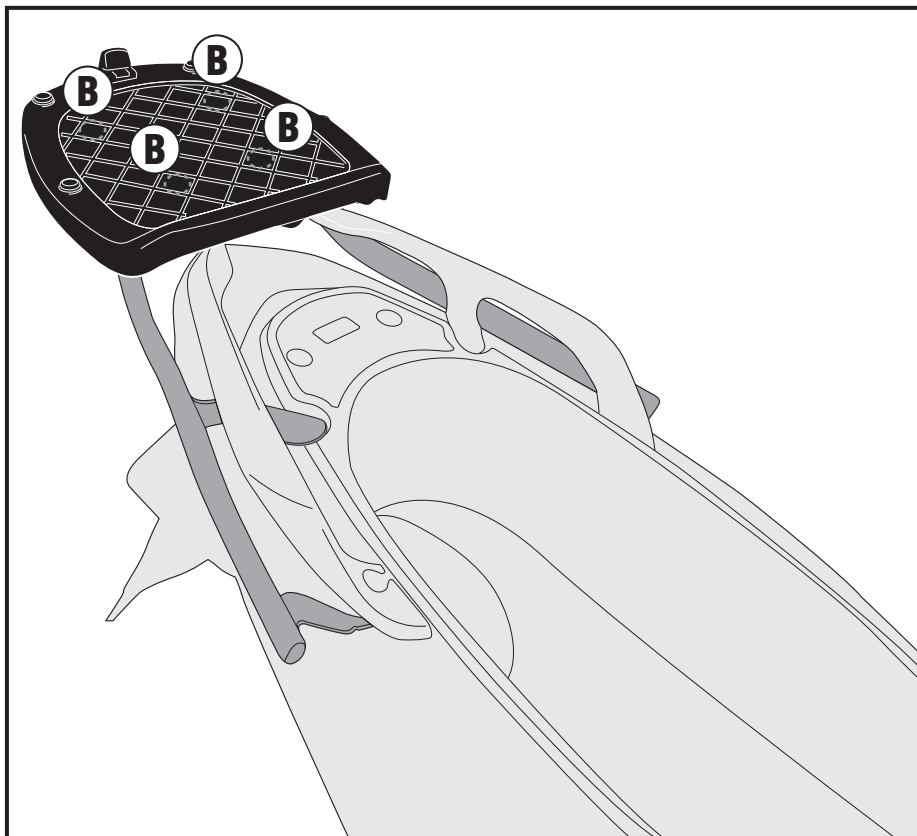

ISTRUZIONI DI MONTAGGIO - MOUNTING INSTRUCTIONS
INSTRUCTIONS DE MONTAGE - BAUANLEITUNG
INSTRUCCIONES DE MONTAJE - INSTRUÇÕES DE MONTAGEM